

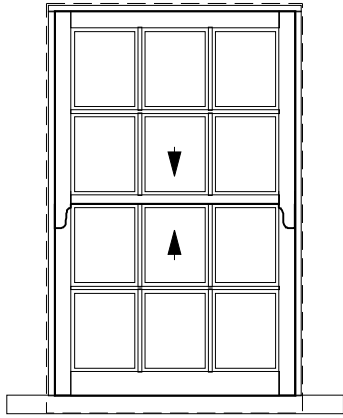

# STANDARD DETAILS

## Double/Single Hung, Slider SHEET INDEX

<u>SHEET</u>	<u>WINDOW TYPE</u>
1.02	ELEVATIONS, DBL/SGL HUNG, SLIDER
	Ø DBL HUNG / SLIDER
2.17-2.19	DOUBLE HUNG (DH), (SH) SIM
2.20-2.21	SLIDER (SL)



DOUBLE HUNG (DH)

FIXED UPPER

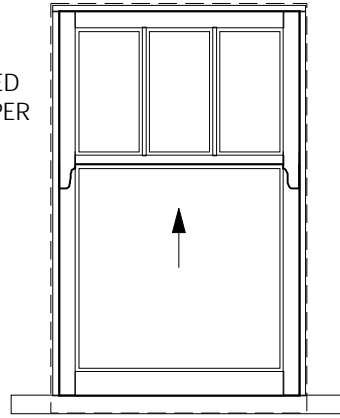

SINGLE HUNG (SH)

COTTAGE  
STYLE

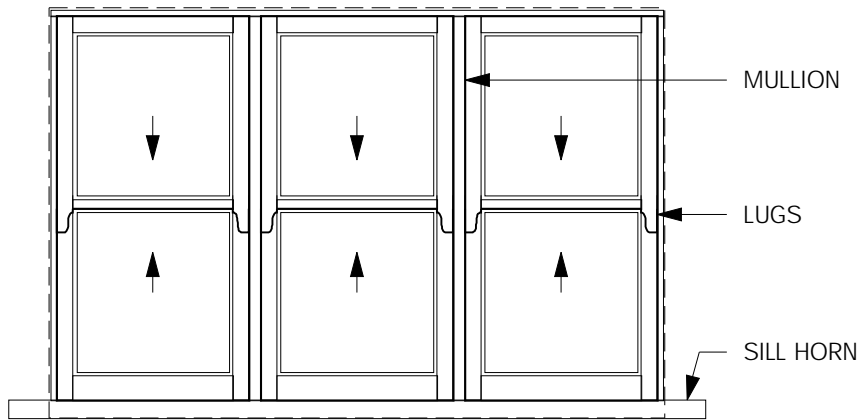

DH X 3 GANG

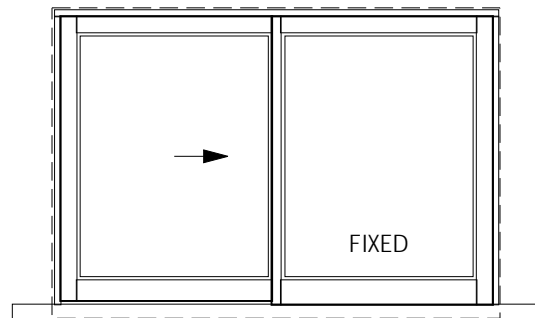

SLIDER (SL)

HUNG / SLIDER WINDOWS

----- SHORT DASHED LINE INDICATES BY OTHERS

SAMPLE EXTERIOR ELEVATIONS	1/2" = 1'-0"		7/14/04
STANDARD DETAILS		APPROVED	SHEET <b>1.02</b>

DATE

SHEET

1.02

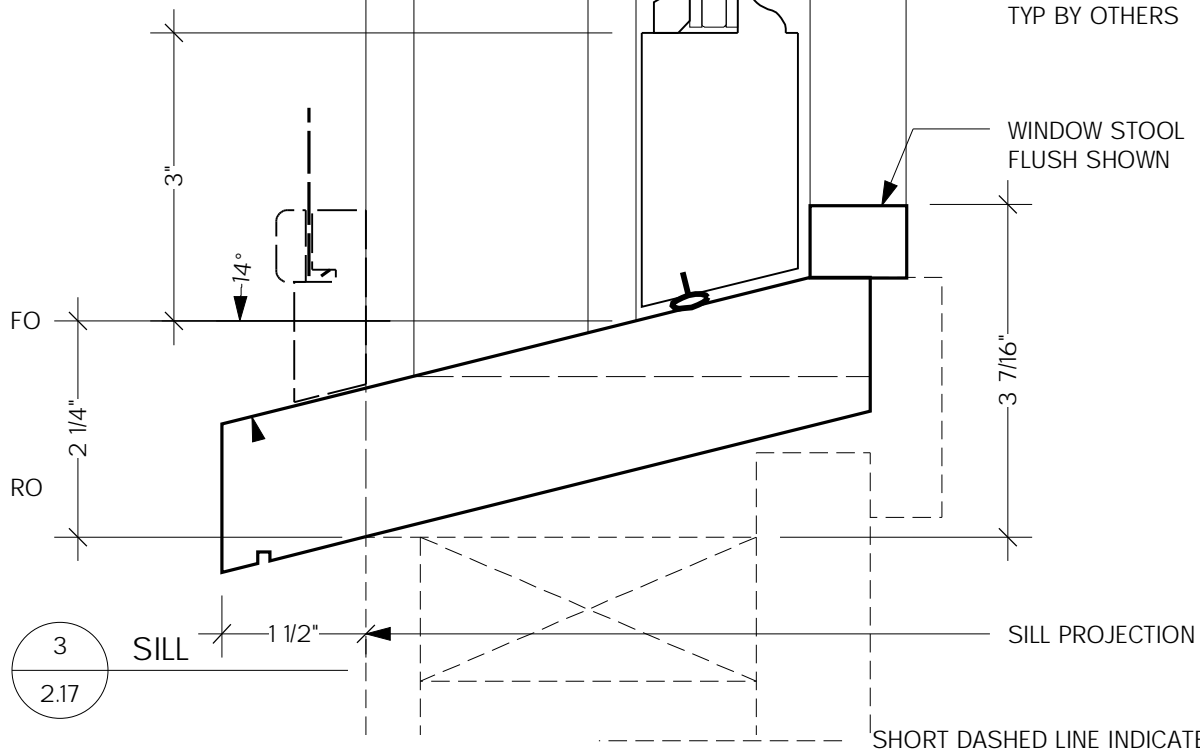
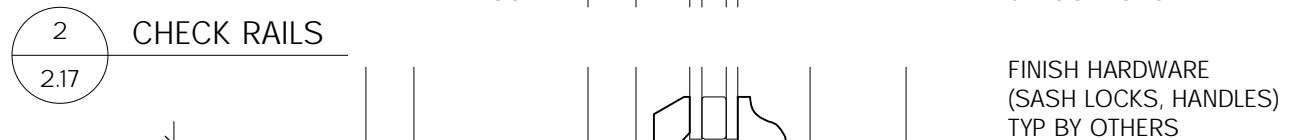
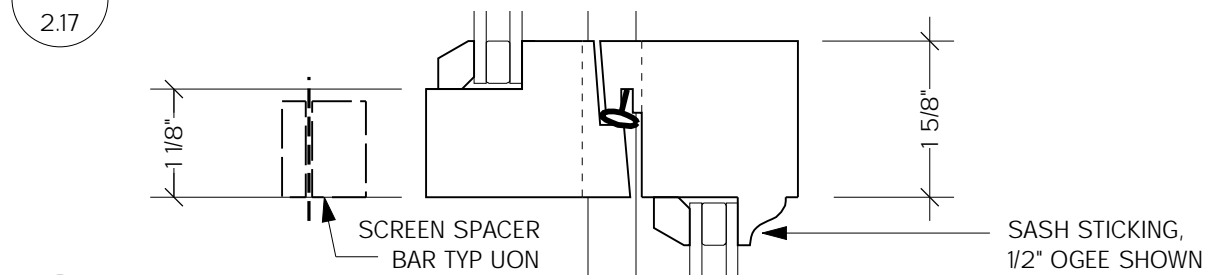
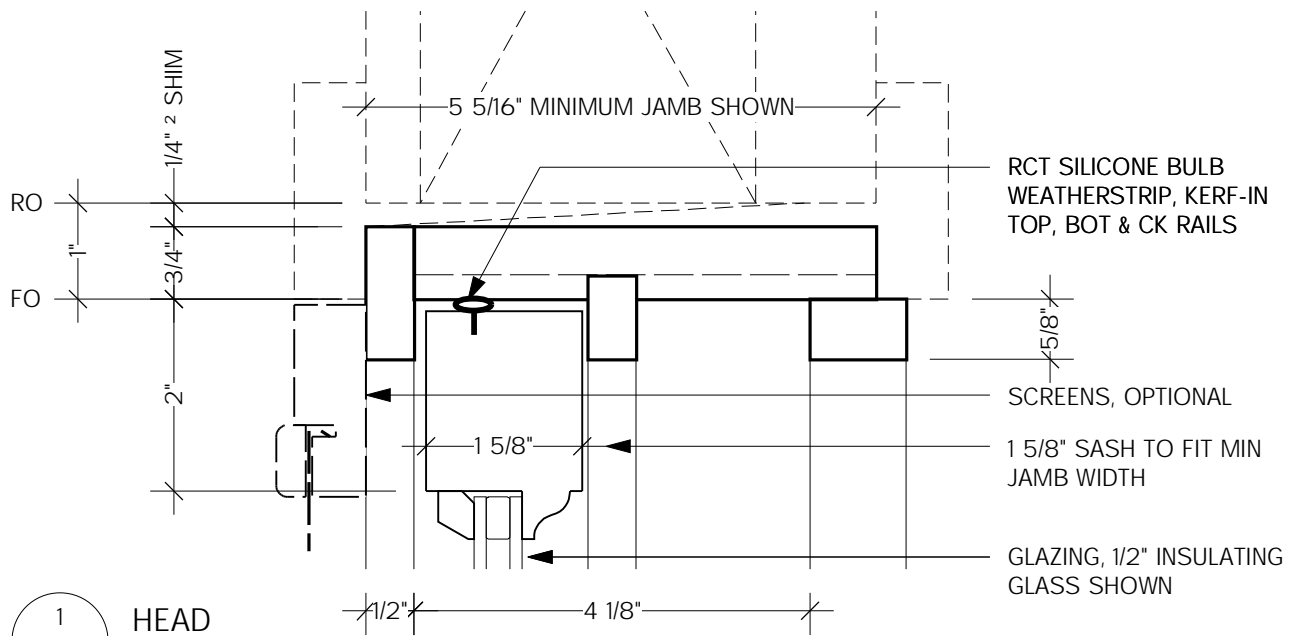

DOUBLE HUNG (DH)	1/2 FULL SIZE		7/14/04
STANDARD DETAILS	<b>SEBASTOPOL</b> WINDOW COMPANY	APPROVED	SHEET 2.17

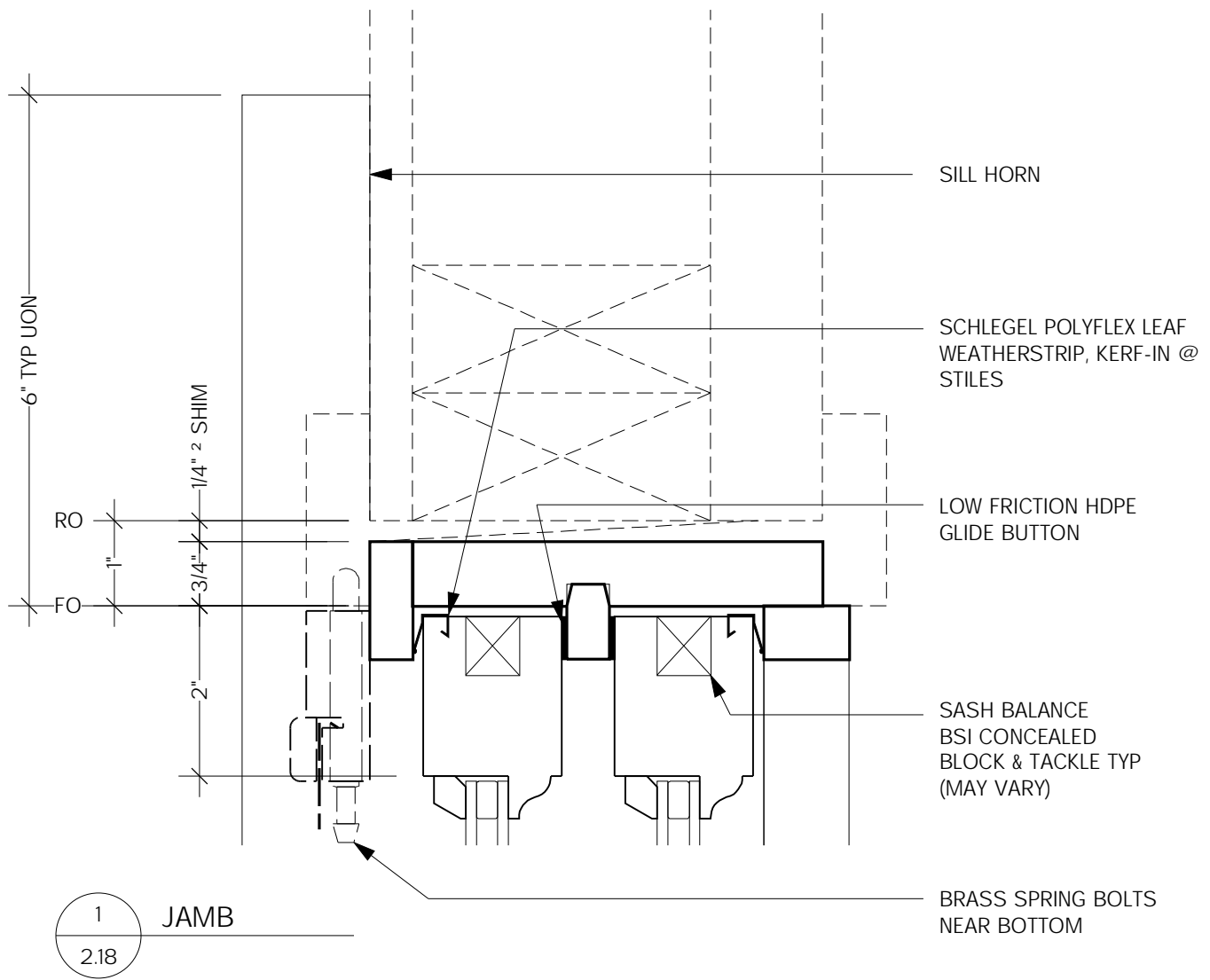

----- SHORT DASHED LINE INDICATES BY OTHERS

DOUBLE HUNG (DH)	1/2 FULL SIZE		7/14/04
STANDARD DETAILS	<b>SEBASTOPOL</b> WINDOW COMPANY	APPROVED	SHEET 2.18

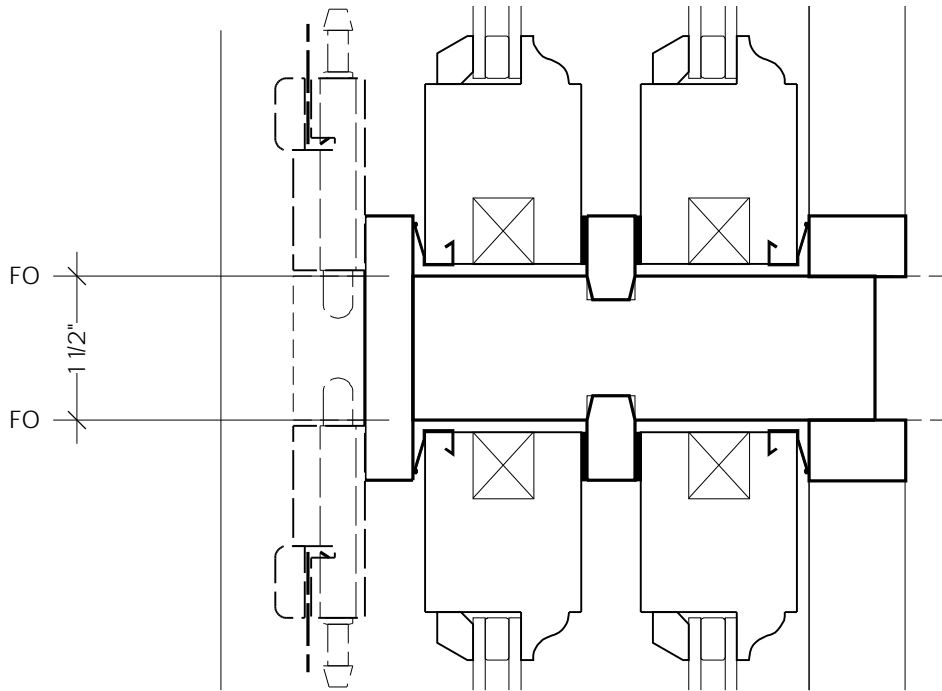

1 MULLION  
2.19

----- SHORT DASHED LINE INDICATES BY OTHERS

DOUBLE HUNG (DH)	1/2 FULL SIZE		7/14/04
STANDARD DETAILS	<b>SEBASTOPOL</b> WINDOW COMPANY	APPROVED	SHEET 2.19

DATE

SHEET

StdetWEB.mcd

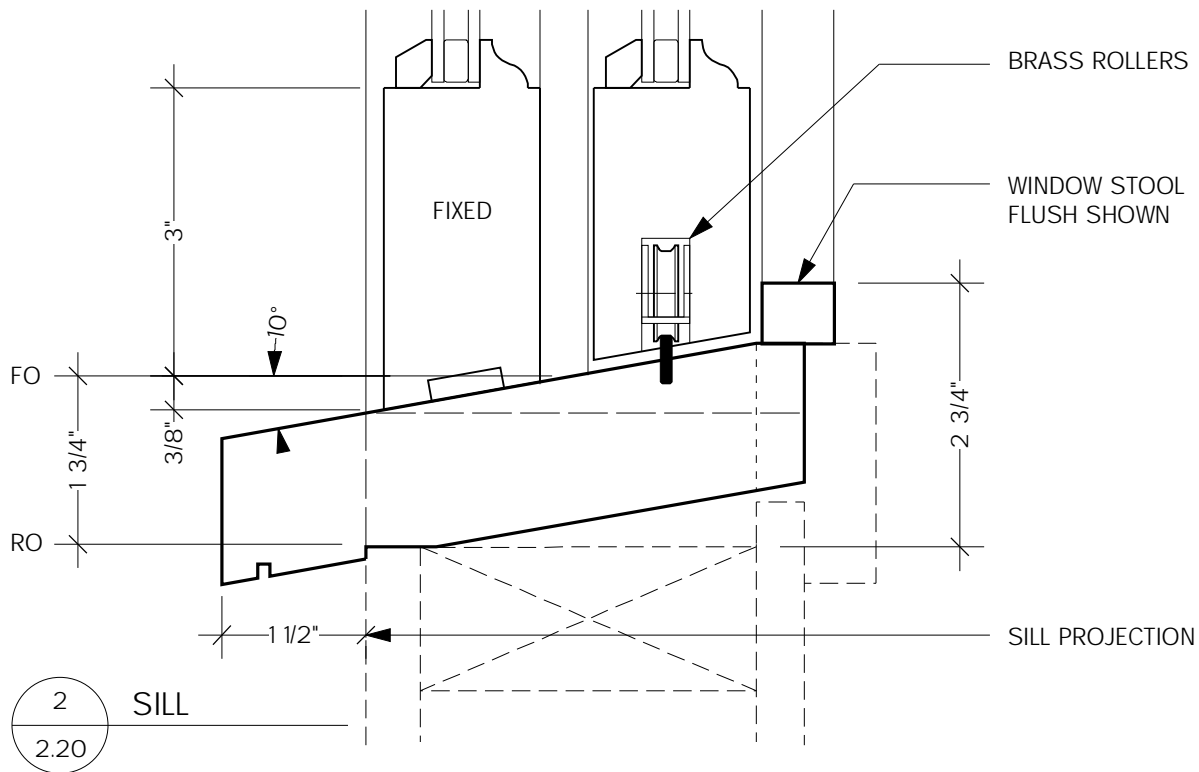
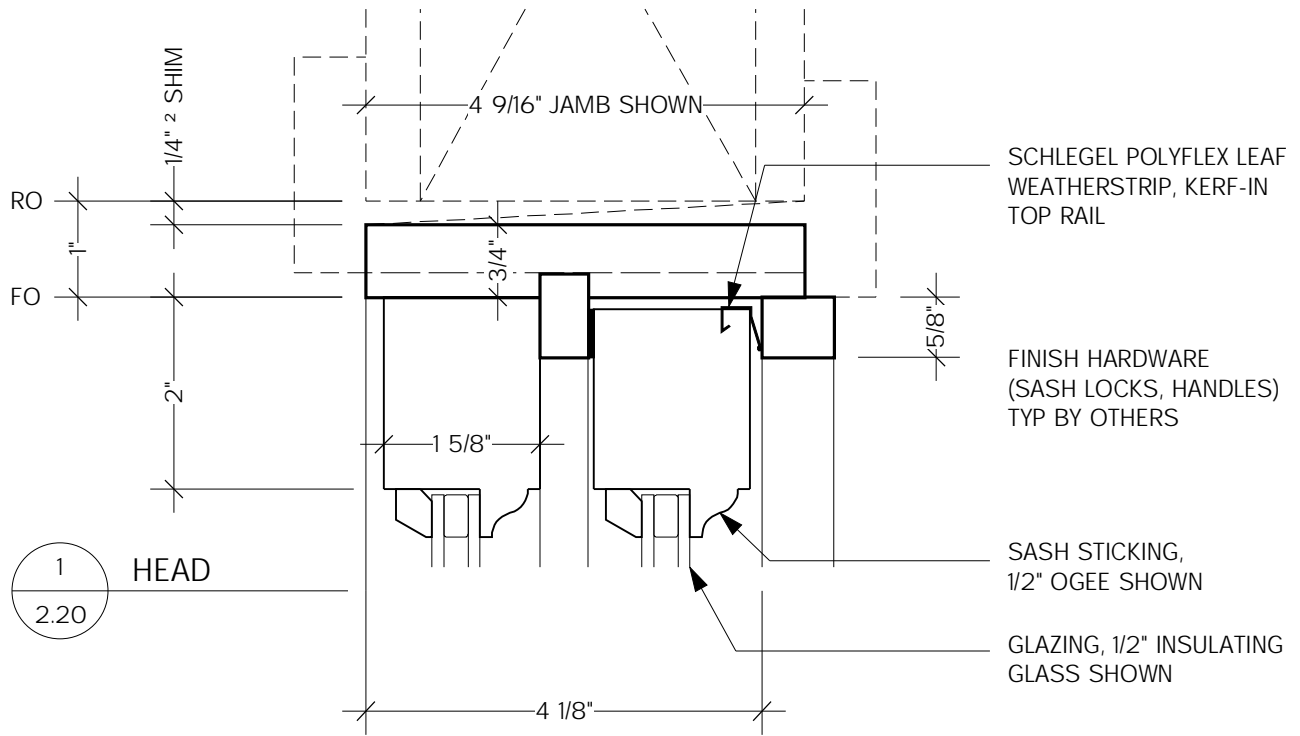

SLIDER (SL)	1/2 FULL SIZE		7/14/04
STANDARD DETAILS	<b>SEBASTOPOL</b> WINDOW COMPANY	APPROVED	SHEET <b>2.20</b>

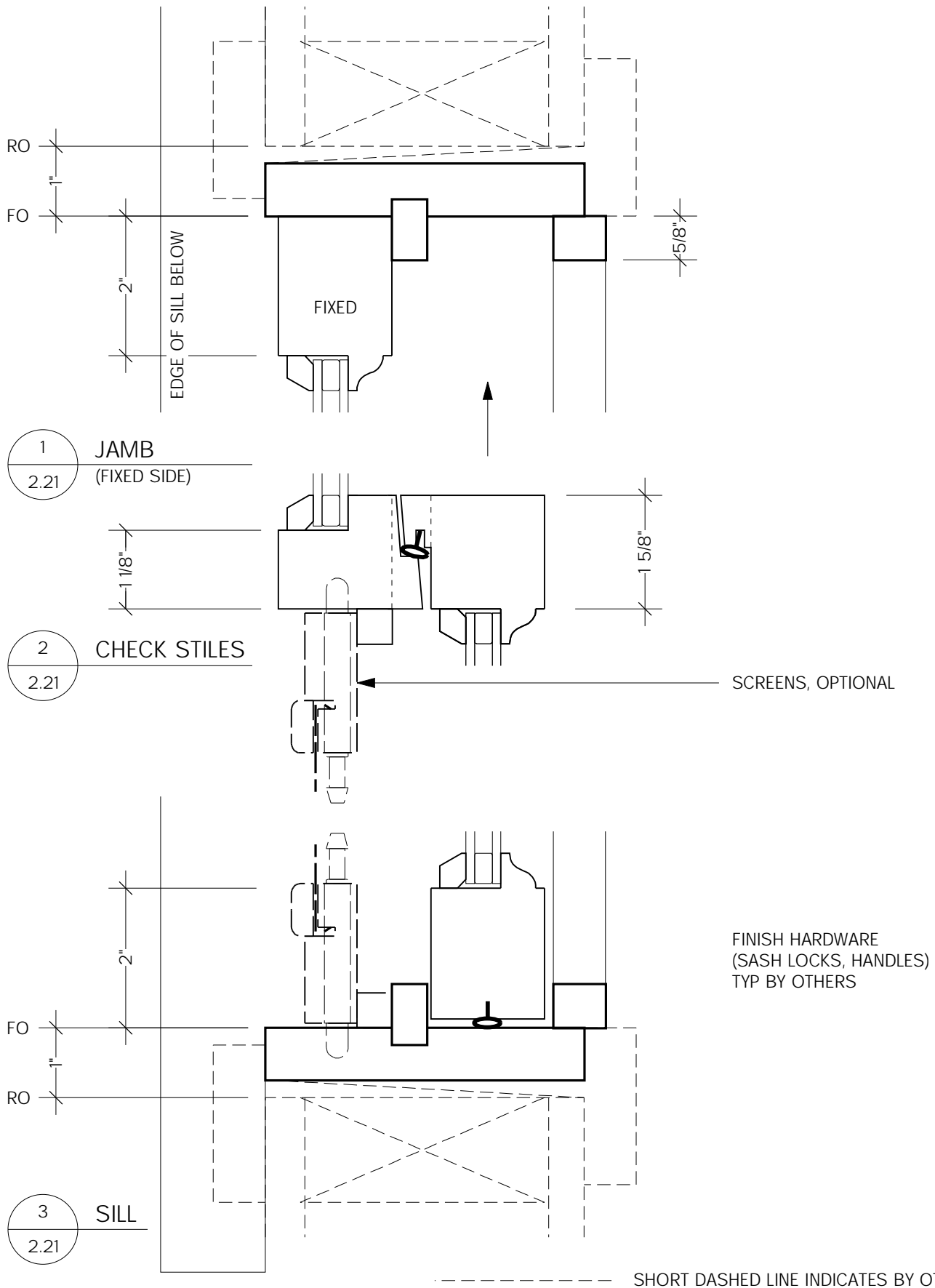

SLIDER (SL)	1/2 FULL SIZE		7/14/04
STANDARD DETAILS	<b>SEBASTOPOL</b> WINDOW COMPANY	APPROVED	SHEET 2.21